

THIS DRAWING IS UNPUBLISHED. RELEASED FOR PUBLICATION .19  
 © COPYRIGHT 19 BY AMP INCORPORATED. ALL RIGHTS RESERVED.

LOC	DIST	REVISIONS					
		P	LTR	DESCRIPTION	DATE	DWN	APVD
DY	-	A		REVISED ECR-07-027079	13NOV07	LWY	SYJ

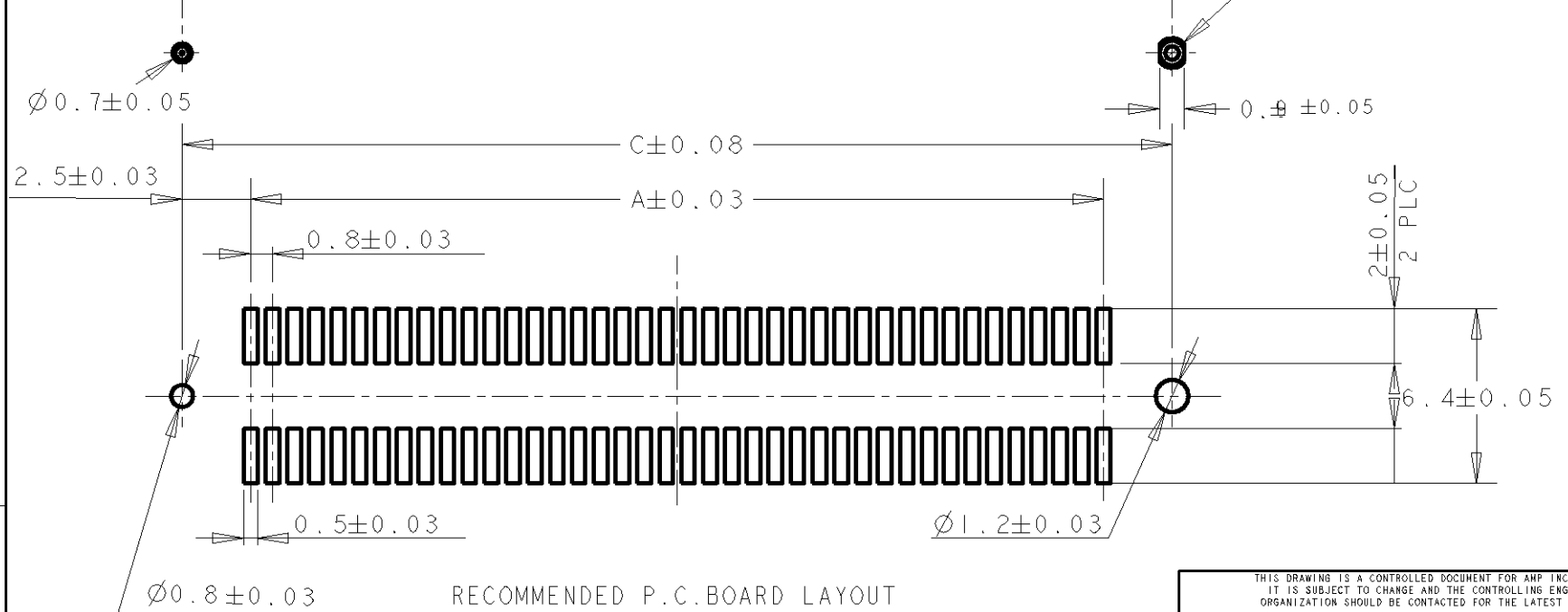
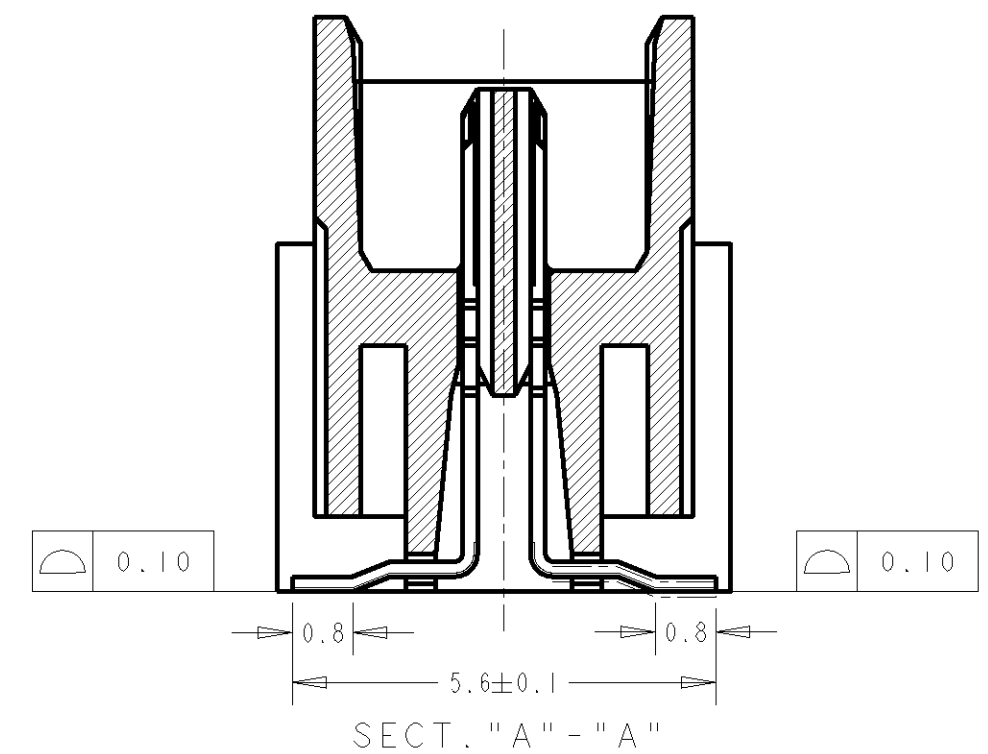
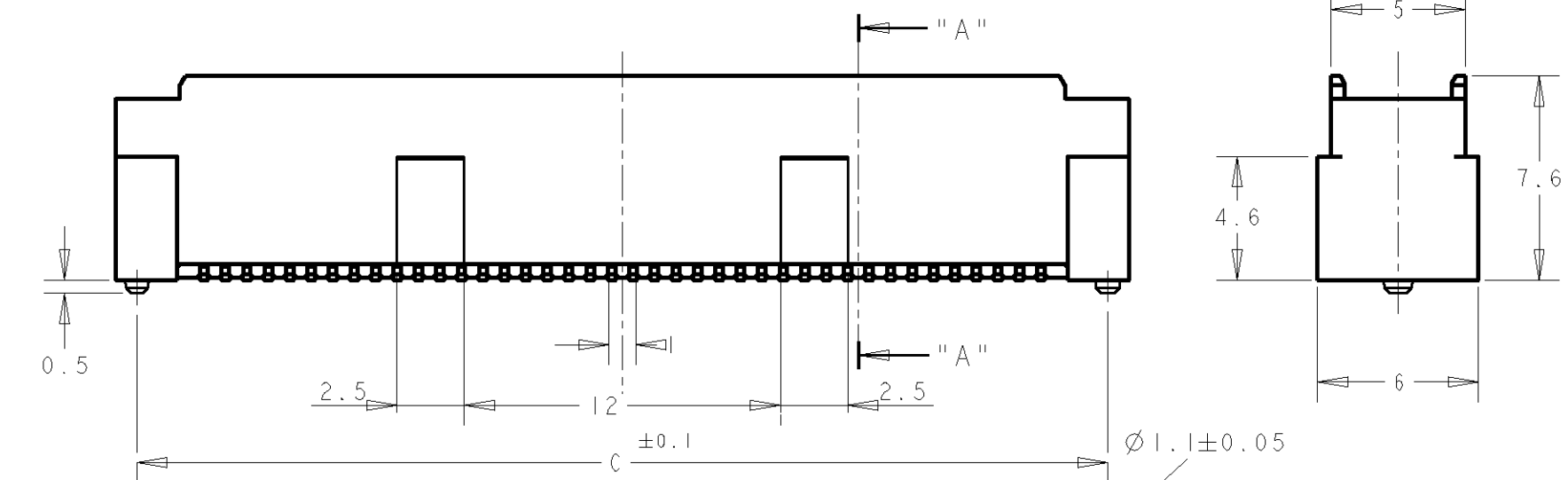
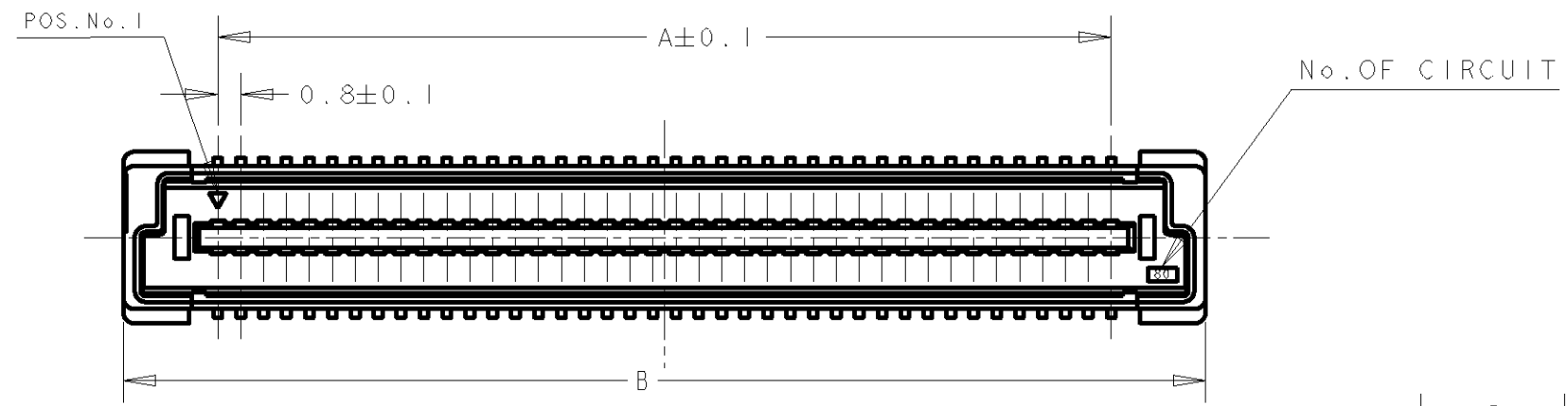

- NOTES:
- △ MATERIAL:  
HOUSING: L.C.P(HIGH TEMP THERMO PLASTIC)  
UL 94V-0, NATURAL.  
CONTACT: BRASS.
  - △ FINISH:  
CONTACT AREA: 0.0002 MIN GOLD ON  
0.0013 MIN ALL OVER NICKEL.  
SOLDERING AREA: 0.002 MIN MATTE-TIN
  - 3. POSITION SERIES: SEE TABLE.
  - 4. CONN STACK HEIGHT COMBINE OF PLUG "Y"H VS REC "X"H.  
STACK HEIGHT = Y + X - 5

RECOMMENDED P.C. BOARD LAYOUT

THIS DRAWING IS A CONTROLLED DOCUMENT FOR AMP INCORPORATED. IT IS SUBJECT TO CHANGE AND THE CONTROLLING ENGINEERING ORGANIZATION SHOULD BE CONTACTED FOR THE LATEST REVISION.		DWN 28 JUL 04 FLORENCE TAN	Tyco Electronics Corporation Singapore	
DIMENSIONS: mm		CHK ERIC TNG	NAME PLUG ASSEMBLY 8H TYPE (0.5 BOSS LENGTH) FOR FH 0.8MM PITCH B-T-B CONNECTOR	
TOLERANCES UNLESS OTHERWISE SPECIFIED: 0 PLC ±- 1 PLC ±0.30 2 PLC ±0.25 3 PLC ±0.20 4 PLC ±- ANGLES ±3°		APVD SF JFONG	DRAWING NO C-5179031	
MATERIAL △		PRODUCT SPEC 108-5390	SIZE A3	CAGE CODE 00779
FINISH △		APPLICATION SPEC 114-5254	SCALE 4:1	
		WEIGHT -	SHEET 1 OF 2	
		CUSTOMER DRAWING	REV A	

THIS DRAWING IS UNPUBLISHED. RELEASED FOR PUBLICATION .19 .  
 © COPYRIGHT 19 BY AMP INCORPORATED. ALL RIGHTS RESERVED.

LOC	DIST	REVISIONS			
P	LTR	DESCRIPTION	DATE	DWN	APVD
DY	-	SEE SHEET 1			

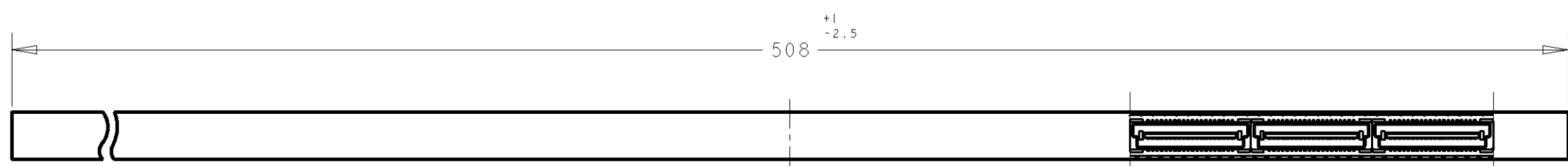

SECT A-A



P/N 9-912056-4 PLUG ASS'Y (H=5mm, W/STEEL COVER), 0.8mm BTB STACKING CONN

SECT B-B

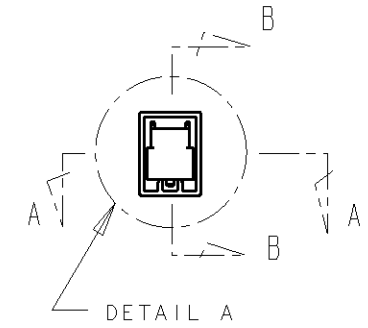

REFERENCE PICTURE OF TUBE PACK

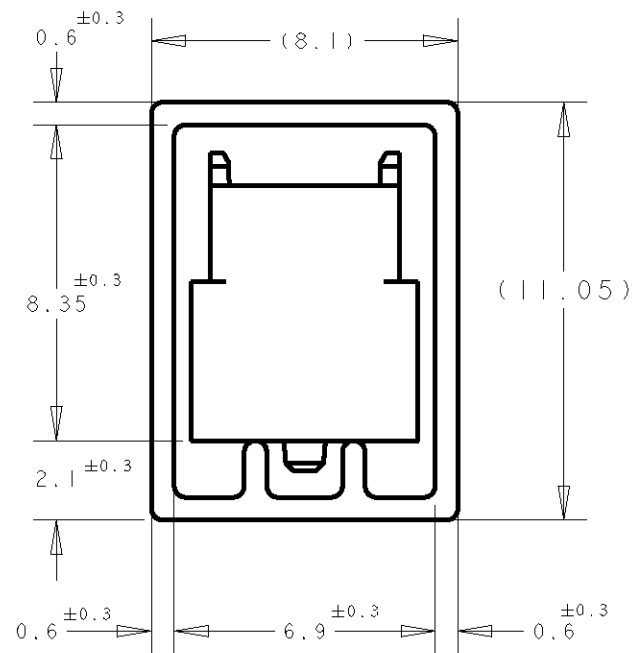

DETAIL "B" (SCALE 5-1)

14	32.2	33.8	27.2	70	1-	-1
5	84.2	85.8	79.2	200	1-	-0
6	76.2	77.8	71.2	180		-9
6	68.2	69.8	63.2	160		-8
7	60.2	61.8	55.2	140		-6
9	52.2	53.8	47.2	120		-5
10	44.2	45.8	39.2	100		-4
12	36.2	37.8	31.2	80		-3
16	28.2	29.8	23.2	60		-2
22	20.2	21.8	15.2	40		5179031-1
QTY/TUBE	C	B	A	POS.	CONN P/N	

THIS DRAWING IS A CONTROLLED DOCUMENT FOR AMP INCORPORATED. IT IS SUBJECT TO CHANGE AND THE CONTROLLING ENGINEERING ORGANIZATION SHOULD BE CONTACTED FOR THE LATEST REVISION.		DWN FLORENCE 28JUL04	Tyco Electronics Corporation Singapore		
DIMENSIONS: mm		CHK ERIC TNG	NAME PLUG ASSEMBLY 8H TYPE (0.5 BOSS LENGTH) FOR FH 0.8MM PITCH B-T-B CONNECTOR		
TOLERANCES UNLESS OTHERWISE SPECIFIED: 0 PLC ± 1 PLC ±0.30 2 PLC ±0.25 3 PLC ±0.20 4 PLC ± ANGLES ±3°		APVD SEIFONG	DRAWING NO 5179031		
MATERIAL		PRODUCT SPEC 108-5390	SIZE A3	CAGE CODE 00779	SHEET 2 OF 2
FINISH		APPLICATION SPEC 114-5254	SCALE 4:1		
MATERIAL		WEIGHT -	REV A		
MATERIAL		CUSTOMER DRAWING			